

SPEEDEO CONNECT

Download on the
App Store

GET IT ON
Google Play

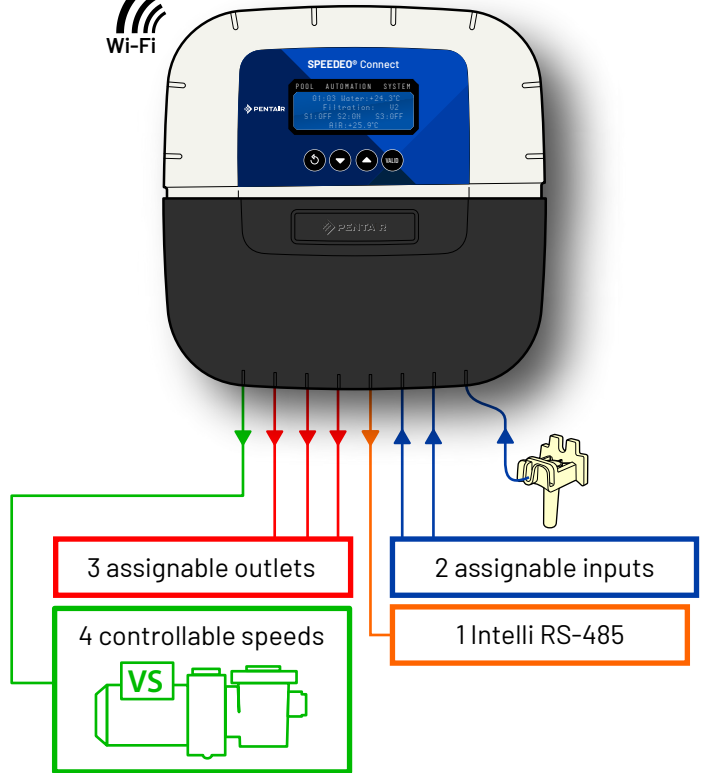

* Speedeo Connect optimises the speed variation of the IntelliFlo pump and is compatible with variable speed pumps with an external connection which permits them to be externally controlled. The list of compatible pumps is constantly changing in accordance with releases of new models.

SB-PF-SPO-004A

INSTALLATION AND USER MANUAL

IMPORTANT SAFETY INSTRUCTIONS
READ AND FOLLOW ALL INSTRUCTIONS
SAVE THESE INSTRUCTIONS

Pentair thanks you for placing your trust in the company and purchasing a Speedeo Connect, the variable speed pump control automaton, with 3 assignable pieces of equipment. Speedeo Connect will start up the correct speed of the connected variable speed pump according to the hydraulic requirements linked to the event.

Please carefully read this user manual to fully benefit from all of the functions of Speedeo Connect. Store it carefully so that it can be consulted at any time.



Declaration of conformity

Directives – Harmonised standards

Pentair International Sarl - Avenue de Sévelin 20 - 1004 Lausanne - Switzerland

We declare, under our own responsibility, that the product meets the directives

RED 2014/53/EU

SAFETY EN 62368-1:2014; EN 62311: 2008

EMC EN 301 489-1 V2.2.0; EN 301 489-3 V2.1.1; EN 55024: 2010 / A1: 2015

RADIO EN 300 220-2 V3.1.1

Speedeo Connect

SB-PF-SPO-004A

PART NUMBERS:

SB-SE-TEC-008A

Other normative documents

Authorised person for technical documentation

Pentair International S.a.r.l
Avenue de Sévelin 20
1004 Lausanne - Switzerland

Lausanne, 2022 01 26



Jacques Van Bouwel
Engineering Mgr

Product specifications: SB-PF-SPO-004A model

Operating temperature: 0° to 40° C

Maximum operating altitude: 2000 m

Main box (internal use): IP 64

Operating hygrometry: 40% at 75° C

Weight (excluding probes): 1.2 kg

Power supply: 230V ~, 50 Hz

Consumption: 3.2 W

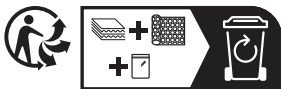

Waste treatment of electronic devices at the end of their service life:

The crossed-out bin placed on the main parts which make up the product indicates that it must not be disposed of with household waste. It must be returned to an appropriate collection point for electronic device recycling (information available from the local household waste collection service). This product contains potentially dangerous substances which may have adverse effects on the environment and human health.

Customer Support: +33(0)1 84 28 09 40

website : www.pentairpooleurope.com

- Warranty (excluding probes and consumables): 2 years

© 2022 Pentair International LLC, All rights reserved - The document is subject to change without notice

Trademarks and disclaimers: Speedeo®, Soleo® and Pentair® are trademarks and/or registered trademarks of Pentair and/or its affiliated companies. Unless indicated otherwise, names and brands of others that may be used in this document are not used to indicate an affiliation or endorsement between the owners of these names and brands and Pentair. Those names and brands may be the trademarks or the registered trademarks of these parties, or others.

Summary

PRESENTATION

> Possibilities for a pump with variable speeds	p 04
> Packaging contents / Functions of the device	p 06
> Description	p 06

INSTALLATION - SPECIFIC POINTS

> Fixing connections / hygiene	p 07
> Examples of installation types	p 09
> Water and air temperature probes	p 10
> Connection of IntelliFlo to IntelliRS-485 and other pumps with variable speeds	p 11

MENUS

> Main menu / Radio menu	p 14
> Install / Heating pump / Information menu	p 15
> Filtration time	p 16
> Filtration Speed / Set Time	p 17

CONNECTIONS Inlets / Outlets

> Inlet: connection for the end of a cover line / switch or remote control	p 18
> Outlet: connections for a controller and an IntelliChlor	p 19
> Outlet: connections for heating pump and solar heating	p 20
> Outlet: connections for lighting and a 3-way motorised valve	p 22
> Outlet: connections and automatic washing for a pneumatic valve	p 23
> Washing assisted by 6-way valve	p 24
> Wi-Fi Installation	p 25
> Navigating the menus	p 26

OTHERS

> Updating internal firmware / History menu	p 28
> pH / RedOx / chlorine ratio	p 29

IMPORTANT SAFETY GUIDELINES, READ AND FOLLOW ALL OF THE INSTRUCTIONS, KEEP THESE INSTRUCTIONS



GENERAL POINTS

- **DANGER** - INSTALLERS, POOL SPECIALISTS AND OWNERS MUST CAREFULLY READ THESE WARNINGS AND ALL INSTRUCTIONS BEFORE USING THIS PRODUCT.

- **WARNING** - Most countries regulate the construction, installation and operation of public swimming pools and spas, and the construction of residential pools and spas. It is important to comply with these regulations, many of which directly regulate the installation and use of this product. Consult your local building and health codes for more information.
- **ATTENTION** - This installation and user guide contains important information on the installation, operation and safety of this product. This guide should be provided to the owner and/or user of this product.

INSTALLATION

- **DANGER** - RISK OF ELECTRIC SHOCK or electrocution
- **BEFORE WORKING ON THIS DEVICE** - Always cut the supply to the device at the circuit breaker before maintenance. Failure to do this may lead to death or serious injury to service staff, pool users or others, due to an electric shock.
- **DANGER** - SERIOUS BODILY INJURY OR DEATH CAN RESULT IF THIS PRODUCT IS NOT INSTALLED AND USED CORRECTLY.
- **WARNING** - Before installing this product, read and follow the warnings and instructions of this guide. Failing to follow these warnings and instructions may lead to serious injuries, death or material damage. Refer to www.pentairpooleurope.com for more information linked to this product.
- **WARNING** - Connect the device to a differential interrupter. If this system is used to control the underwater lighting devices, a differential interrupter must be installed upstream of these devices. Conductors downstream of the differential interrupter shall not occupy conduits, junction boxes or enclosures containing other conductors, except if the conductors are also protected by a differential interrupter. Refer to valid local codes for more details.
- **WARNING** - This product must be installed by an authorised or certified electrician or a qualified swimming pool professional. All of the applicable installation codes and local regulations must also be respected. Poor installation will create an electrical hazard which could result in serious injury or the death of pool users, installers or others due to electric shocks, and may also cause damage to property.
- **DANGER** - DISCONNECT THE SUPPLY CONNECTIONS BEFORE WORKING ON THIS DEVICE; ELECTRICAL POWER MAY BE SUPPLIED TO THE RELAY TERMINALS FROM OTHER SOURCES.
- **WARNING - CHEMICAL BURN HAZARD:** Make sure all pumps are switched off at the main circuit breakers at the domestic distribution board before drilling into any pipes. Set rules for all handling related to electrical aspects, water and chemical products. Group the supply pumps and chemical product tanks in a safe and secured area.
- **WARNING** - Do not use this product to control an automatic swimming pool cover. There is a risk that swimmers could become trapped under the cover.
- **WARNING** - Devices which are not intended for use in single-family dwellings may require additional safety equipment to comply with local regulations.
- **DANGER** - Except for remote controls, maintain a distance from the inside wall of the pool or spa that shall comply with the standards in force in your country.
- **DANGER** - This product is intended for use in swimming pool applications only.
- **WARNING** - If the device is installed and / or used contrary to specifications and recommendations, the protections will be compromised.

USE

- DANGER - DO NOT LET CHILDREN OPERATE THIS EQUIPMENT.

- **WARNING** - Strictly respect the safety and handling procedures from the acid manufacturers, including protective measures for hands, body and eyes during transferring and using acid. Follow the prescribed safety precautions for handling muriatic acid intended for checking the water pH. Muriatic acid may cause serious physical harm and may damage the swimming pool equipment. Extra care must be taken when installing, maintaining and operating the acid pump feed systems. Acid is dangerous to handle and should be properly contained, transported, poured, stored and dispensed.

- **WARNING** - Check the pH and sanitizer levels of the water before using the pool and make sure the filtration device is not obstructed.

- **WARNING** - Periodically use an independent pH and chlorine testing kit to ensure that the pH and chlorine is at a safe level. If the pH and Oxidation Reduction Potential (ORP) or conductivity probes are broken, depleted or dirty with oils, lotions, or other contaminants, they can report inaccurate results to the system causing incorrect water chemistry, which could harm people or equipment.

- **WARNING** - Consult the device display daily to ensure there are no alarm messages.

- **DANGER** - Water temperatures greater than 37.7° C (100° F) are a health hazard. Prolonged immersion in hot water may induce hyperthermia. Hyperthermia occurs when the internal body temperature exceeds the normal temperature of 37° C (98.6 °F) by several degrees. Hyperthermia may produce the following effects: (1) Unawareness of impending danger. (2) Failure to perceive heat. (3) Failure to recognise the need to leave the spa. (4) Physical inability to leave the spa. (5) Harm to the foetus in pregnant women. (6) Unconsciousness leading to the risk of drowning. The use of alcohol, drugs or medicine is a factor which increases the risk of hyperthermia in hot tubs and spas.

- **WARNING** - When mixing acid with water, ALWAYS ADD THE ACID TO THE WATER. Never add water to the acid. When adding a chemical product to the swimming pool, carefully follow the manufacturer instructions.

- DANGER - DO NOT MIX SODIUM HYPOCHLORITE AND MURIATIC ACID.

- **DANGER** - Keep standard solutions away from children, ensure that the bottles are securely closed, store them in a dry and ventilated location and do not let them freeze. The pH 4 calibration solution is acidic.

ELECTRICAL WIRING RULES : This product must be installed by a licensed or certified electrician or a qualified pool professional in accordance with the local regulation depending country :

A = ÖVE 8001-4-702

B = ARE1 / RGIE

D = DIN VDE 0100-702

EW = EVHS-HD 384-7-702

GB = GS7671:1992

I = CEi 64-8/7

LUX = 384-7.702 S2

NL = NEN 1010-7-702

PL = PN-IEC 60364-7-702:1999

SLO = SIST HD 384-7-702.S2

CZ = CSN 33 2000 7-702

E = UNE 20460-7-702 1993, RECBT ITC-BT-31 2002 F = NF C15-100

H = MSZ 2364-702/1994/MSZ 10-553 1/1990

IRL = Wiring Rules + IS HD 384-7-702

M = MSA HD 384-7-702.S2

P = RSUUEE

SK = STN 33 2000-7-702

TR = TS IEC 60364-7-702

All applicable local installation codes and ordinances must also be adhered to. Improper installation will create an electrical hazard which could result in death or serious injury to pool users, installers or others due to electrical shock, and may also cause damage to power source. Always disconnect the power to the pool light at the circuit breaker before installing or removing the light. Failure to do so could result in death or serious injury.

Foreword: management possibilities for a pump with variable speed control

i Speedeo Connect is intended to optimally control (via dry contacts [of which one is shared and one is a controllable speed contact, a maximum of four]) the different rotation speeds of a variable speed filtration pump. There are usually 4 speeds: V1, V2, V3, V4. Speedeo Connect makes it possible to launch up to 3 pieces of equipment, whose operation is linked to a speed. The rotation speeds at different speeds are directly pre-set on the control unit (drive) of the pump. Speedeo Connect will therefore select the most appropriate power according to the requirements to save as much electricity as possibility without impairing the filtration quality.

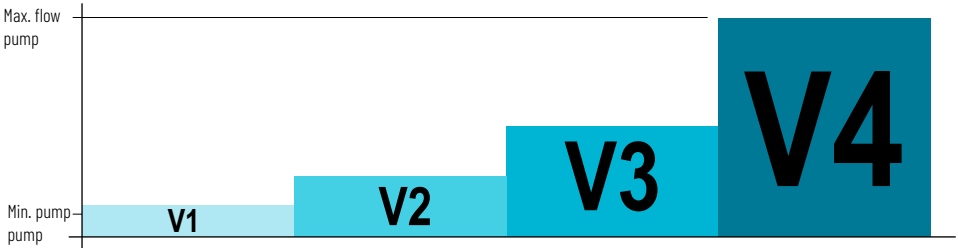

- **Speed 1** : Permits minimal circulation. Speed V1 is used for frost protection and is selected when the cover is placed over the pool (if applicable). V1 will function 24h/day if the water $T^{\circ} > +28.0^{\circ}\text{C}$. This speed is therefore used when there are no bathers in the pool.
- **Speed 2** : Permits circulation of a larger amount of water when the cover is stowed (if relevant). This speed is used when swimmers are in the pool.
- **Speed 3** : Permits a strong flow of water when an accessory requires it. It is often chosen for a counter-current jet, heating, cascade, etc. It is triggered in accordance with the parameters, either by a timer or a wired remote control.
- **Speed 4** : Only used for backwashing of the filter. On some pumps, V4 cannot be adjusted and automatically represents the maximum power.

Example: typical day for a pool at 25.0°C in June in Europe

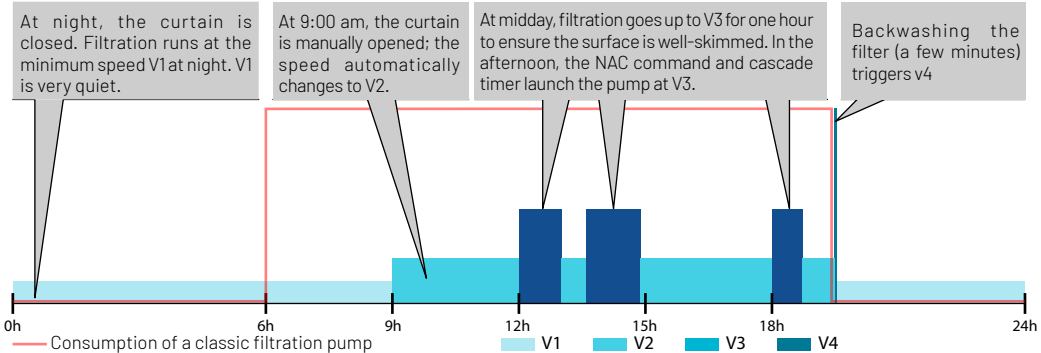

i Dividing the rotation speed of the filter pump by 2 divides its power consumption by 8. The average saving of Speedeo Connect driving a VS pump compared to a conventional 1.5 hp filtration is several hundred euros per year.

Filtration control:

- By calculating the time according to the pool temperature (automatic mode).
- By constant flow management in IntelliFlo pumps
- By programming a 24 hour cycle (makes it possible to benefit from off hours).
- By integrating the frost protection function (activation of the filtration below 3°C, modifiable value).
- By giving priority to the heating (if the value of this reference exceeds the set value, and if the filtration is cut, filtration starts in the next 15 minutes).
- Possibility to select the start time and end time of the filtration in automatic mode (to prevent noise at night). If Speedeo Connect is connected to a SOLEO, this function is found on SOLEO.
- Possibility to increase or reduce the filtration time according to the use of the swimming pool (economical mode = pool with a low number of visitors, turbo mode = pool with a high number of visitors) or by default + or - 30% (value can be adjusted).
- Possibility to change into "SHOCK" mode (forcing of the filtration and electrolyser for 24 hours).
- Possibility to change the speed according to the position of the pool cover (motorised cover) if there is a position contact connection on the dedicated inlet.
- Possibility to change the speed according to the position of a command (interrupter, end position sensor of the motorised cover).

Control of 3 devices:

- By synchronisation with operation of the pump (each connected device will only be authorised to operate if the filtration runs at a sufficient rate).

Speedeo Connect also makes it possible to visualise, on its screen (in the technical room):

- time
- water temperature
- operating speed (S1 to S4)
- status of the 3 outlets (S1 S2 S3, ON or OFF)
- air temperature (if second sensor present)

THEREFORE IN SUMMER AND WINTER, YOU NO LONGER NEED TO WORRY ABOUT YOUR FILTRATION AND YOU LIMIT THE INTERVENTIONS IN THE TECHNICAL ROOM TO A BARE MINIMUM.

Description

i Speedeo Connect automatically controls the pump rotation speed with variable speed, enabling the function of programmed or activated events.

FRONT VIEW

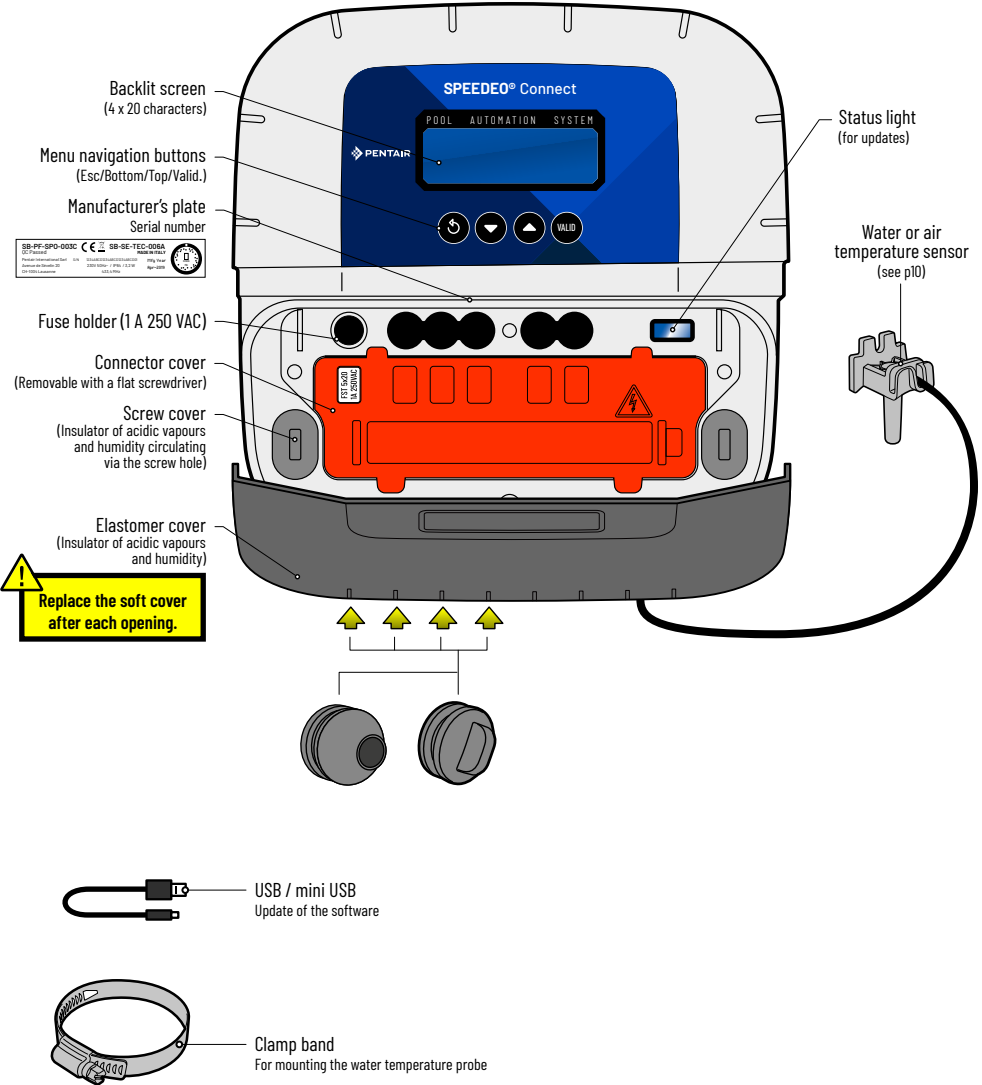

Wall fixing

- ⚠ - This device is intended to be used inside, installed in a technical room which cannot be accessed by children.
- Set the device at a height lower than 2 m using three screws (4 to 5 mm diameter) in appropriate plugs for the type of support and fix the device vertically on a clean support which is able to bear a minimum vertical load of 5 kg.

Pierce three holes in accordance with the below dimensions then place 3 suitable plugs.

- 1 - Tighten the screw at the top, leaving 2 mm under the screw head, then hang the device on this.
- 2 - Place the 2 lower screws.
- 3 - Add the 2 lower screw covers to ensure a full seal.
- 4 - No metallic element or electrical cable must pass less than 20cm from the top/right corner of the device (radio zone).

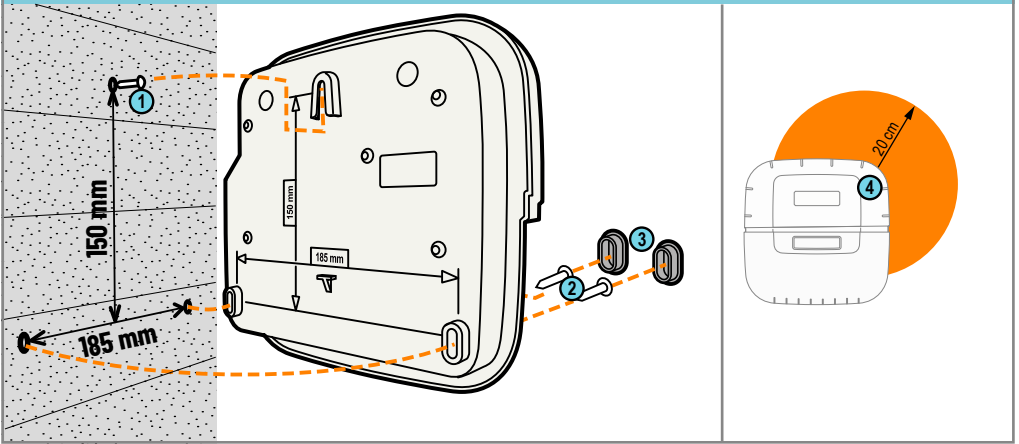

- i A safety cover which cannot be unclipped without a tool is positioned above the connectors which provide the voltage. > Place a flat screwdriver on the flat part of clips 2 and 3, while keeping pressure on to unclip it.

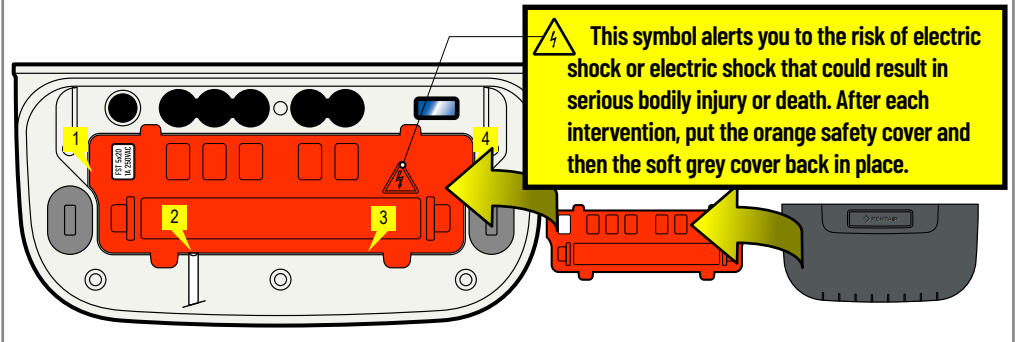

Electrical connections regulation

- ⚠ - The device must be installed by a qualified technician according to valid local regulation
- This device is permanently connected.
- The 2 poles of the power supply of the device is cut by its interrupter, which must be close and must remain accessible at all times.
- The device needs to be connected to the earth and its power supply needs to be protected by 16A 30 mA differential protection. This protection must be cut before any intervention on the device.
- Overvoltage category II (2,500 V peak) electrical device. If necessary, place overvoltage protection equipment before the device.
- The device must be placed close to the electrical cabinet to aid connections (3 m max.).

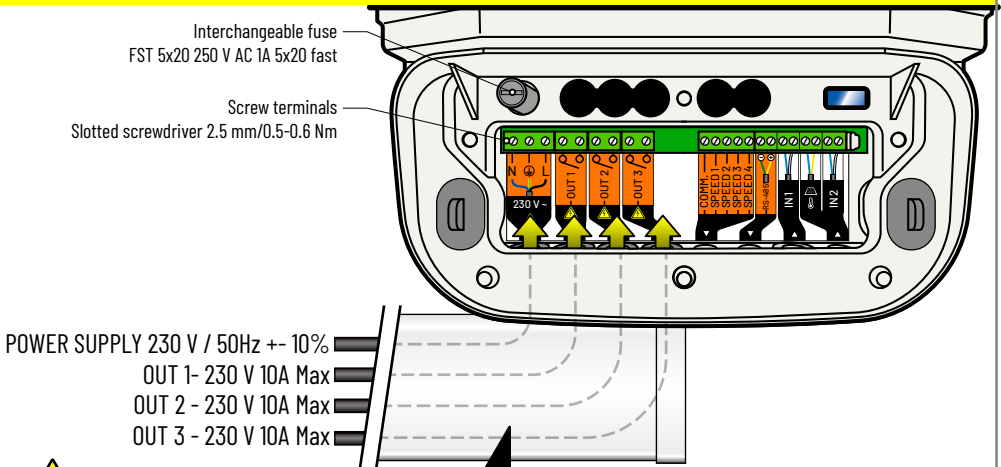

⚠ The supply cable as well as the cables of the dry power contacts must be placed in a channel according to the EN 50085-2-1 standard, 35mm thick, plated and closed under the device and installed according to the IEC 60364 standard.

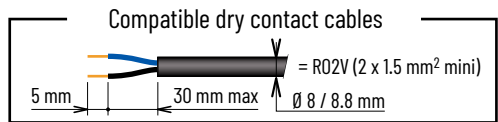
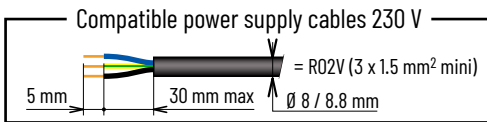

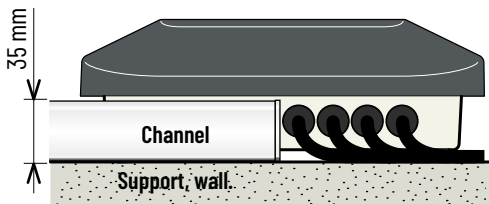

BOTTOM VIEW

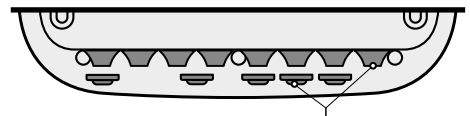

REAR VIEW



-  **Caps**
- must be installed if an outlet is not in use
(to stop any humidity or acidic vapour entering)
-  **Cable ducts**
- must be installed if an outlet is in use,
(to stop any humidity or acidic vapour entering)

Examples of installation types

- **Inlet connections:** Water temperature, cover presence sensor
- **Outlet connections:** Heating, electro-pneumatic valve, solenoid valve

Indicative connections

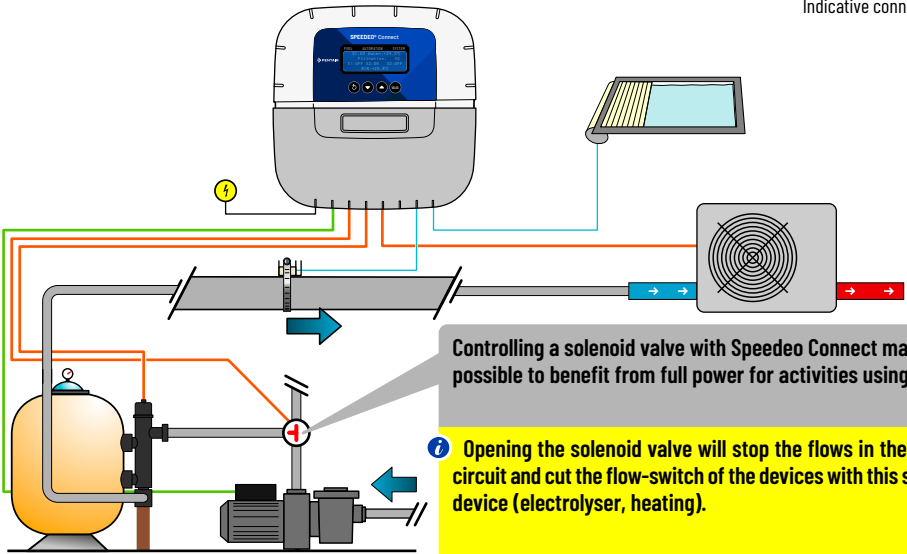

- **Inlet connections:** Cover presence sensor
- **Outlet connections:** Heating, solenoid valve

Indicative connections

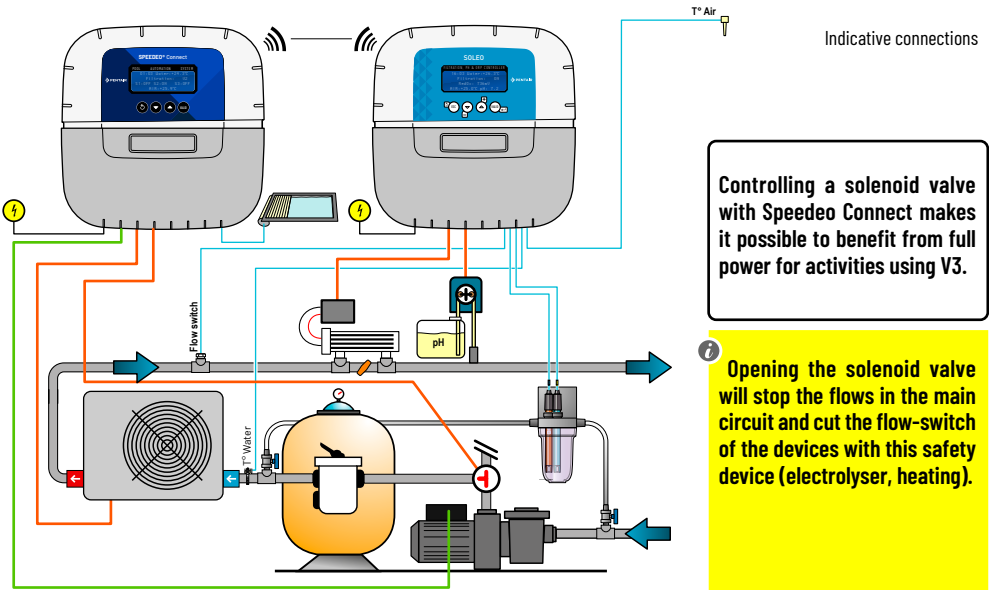

Water and air temperature probes.

- i** Speedeo Connect is supplied with a temperature probe which is suitable for water. It is possible to mount a second temperature probe for the air temperature used to manage the frost protection process of heated technical rooms. The probe time can be staggered via the Temperature Menu > Calibration: (see p15)
- i** - Once Speedeo Connect is linked to a SOLEO, the temperature values saved and displayed by Speedeo Connect are picked up by the SOLEO. The temperature sensor provided can also be used as an air temperature sensor.

INSTALLATION OF THE WATER TEMPERATURE PROBE

The temperature probe can be installed outside the bypass in front of the filter of the pump or in front of the filter inlet in order to improve the reading precision.

- 1 - Pierce the PVC pipe (diam. 50-70 mm) to a diameter of 10 mm (3/8 inch).
- 2 - Remove the burrs and check the O-ring under the probe.
- 3 - Place the sensor in the hole, then place the clamp band in the groove and tighten.
- 4 - Connect wires to dedicated terminal block.

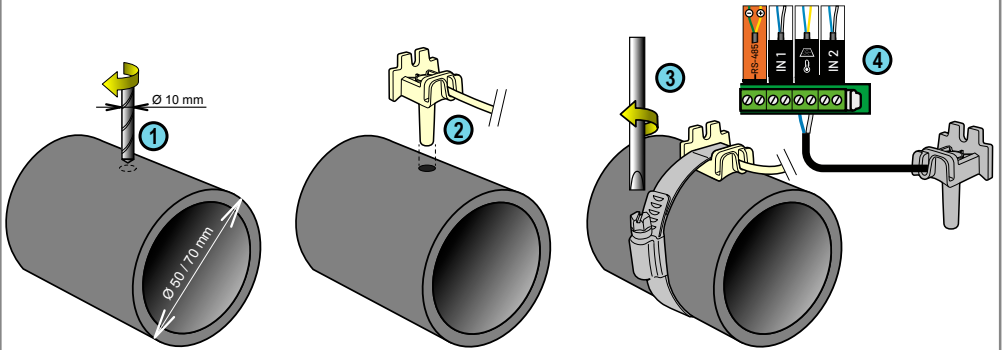

INSTALLATION OF THE AIR TEMPERATURE PROBE (OPTION)

- If the air temperature probe is connected, it automatically becomes the reference value for freeze protection management (unless Speedeo Connect is connected to a SOLEO). The air temperature probe is placed outdoors, away from direct sunlight so that the measurement is not distorted. It can be easily moved due to its 6 m long cable.

- 1 - Mount it on a wall with screws.
- 2 - Mount it on a horizontal bar of a grate with a cable tie.

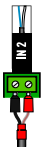
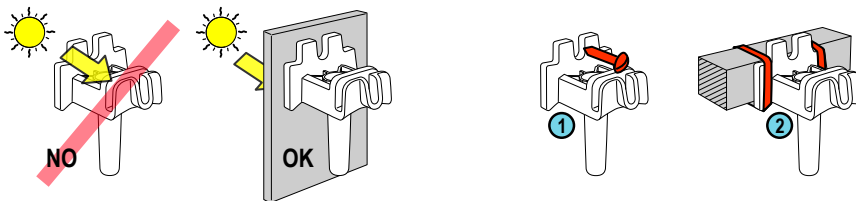

- 1 - Connect the cables to Inlet 2 in accordance with the diagram.
- 2 - Start the secured Install menu (on the main menu, press Esc and Valid at the same time for 3 secs. A star appears in the top right corner of the home screen).
- 3 - In the Inlets / E1-E2 sub-menu (in accordance with chosen terminal), select T° Air to indicate that a temperature sensor is connected to the corresponding inlet.

PENTAIR IntelliFlo: Connections and functions

- i** Connect the pump to the 230 V, connect to the 10-m long IntelliFlo cable (ref 350122), the green/yellow to the 'RS-485', adhering to the colours.

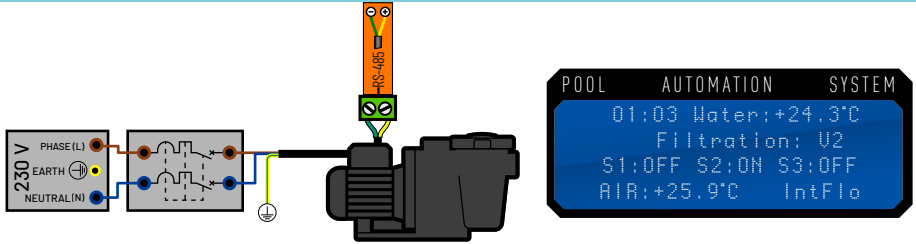

- 1 - Connect the cables in accordance with the diagram.
- 2 - Start the secured Install menu (on the main menu, press Esc and Valid at the same time for 3 secs. A star appears in the top right corner of the home screen).
- 3 - On the Filtration Speed / Type sub-menu, select 4 speeds and hold down Valid.
- 4 - Connect wires to dedicated terminal block.

PENTAIR VS2 (Superflo, SuperMax, Ultraflow, S5P2R, Challenger & Whisperflo): Connections and functions

- i** Control the speeds S1 < S2 < S3 < S4 and S4 at 100% on the pump drive.

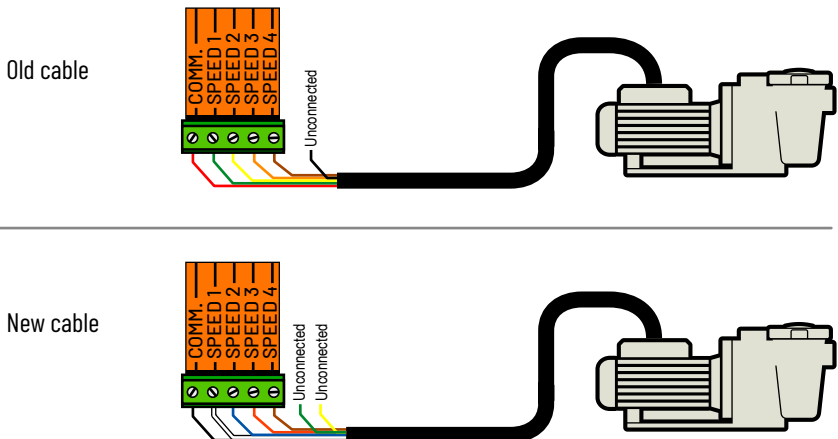

PENTAIR VS1 (Superflo, Ultraflow, SuperMax and S5P2R): Connections and functions

- i** Control the speeds $S1 < S2 < S3 < S4$ and $S4$ at 100% on the pump drive. Set the DIP switches 1, 2, 3, 4 on the pump drive to ON.

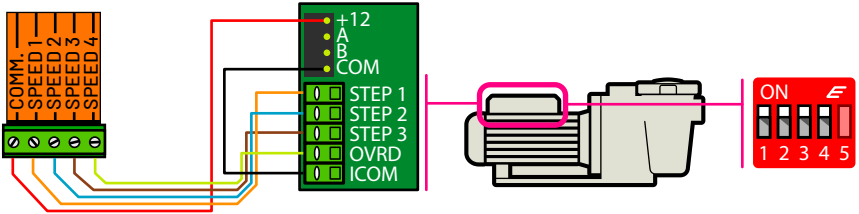

- 1 - Connect the cables in accordance with the diagram.
- 2 - Start the secured Install menu (on the main menu, press Esc and Valid at the same time for 3 secs. A star appears in the top right corner of the home screen).
- 3 - On the Filtration Speed / Type sub-menu, select 4 speeds and hold down Valid.

HAYWARD VSTD: Connections and functions

- i** Set the appropriate speed 1(Eco), 2(Normal), 3(Max) on the HAYWARD pump.



- 1 - Connect the cables in accordance with the diagram.
- 2 - Start the secured Install menu (on the main menu, press Esc and Valid at the same time for 3 secs. A star appears in the top right corner of the home screen).
- 3 - On the Filtration Speed / Type sub-menu, select Invertek and hold down Valid.

SPECK Eco Touch: Connections and functions

- i** Control the appropriate speeds for the pump, 1 (Eco), 2 (Normal) and 3 (Max).
- The SPECK Eco Touch pump functions for 5 minutes at maximum speed after starting.

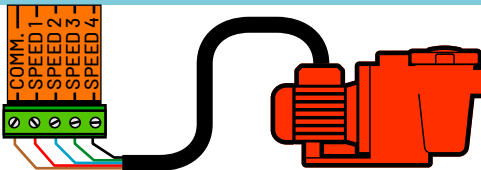

- 1 - Connect the cables in accordance with the diagram.
- 2 - Start the secured Install menu (on the main menu, press Esc and Valid at the same time for 3 secs. A star appears in the top right corner of the home screen).
- 3 - On the Filtration Speed / Type sub-menu, select 3 speeds and hold down Valid.

SPECK 90 Eco Motion: Connections and functions

- i** On the pump, control the speeds $N1 < N2 < N3 < N4$ and $N4$ at 100% / 'EXTERNAL = FIX SPEED' and 'SIGNAL = CONTINUED'. - The pump functions for 5 minutes at maximum speed after starting.

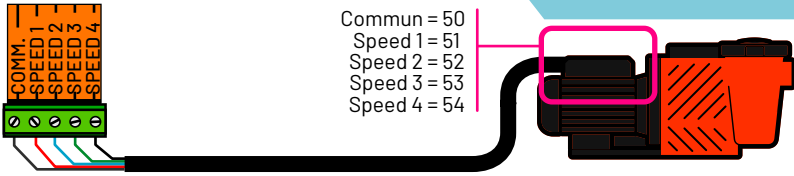

- 1 - Connect a 5 x 0.75 mm² cable in accordance with the diagram.
- 2 - Start the secured Install menu (on the main menu, press Esc and Valid at the same time for 3 secs. A star appears in the top right corner of the home screen).
- 3 - On the Filtration Speed / Type sub-menu, select 4 speeds and hold down Valid.

ZODIAC FloPro VS: Connections and functions

- i** Control speeds $1 < 2 < 3 < 4$ on the pump drive
- Control all operation lengths at '0'

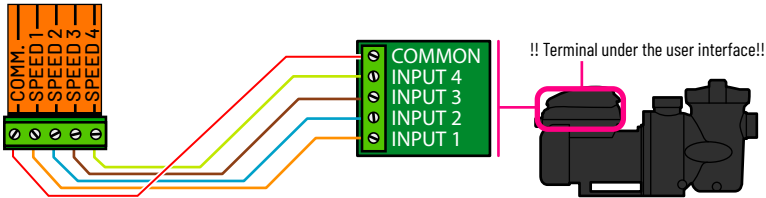

- 1 - Connect the cables in accordance with the diagram.
- 2 - Start the secured Install menu (on the main menu, press Esc and Valid at the same time for 3 secs. A star appears in the top right corner of the home screen).
- 3 - On the Filtration Speed / Type sub-menu, select 4 speeds and hold down Valid.

Main menu

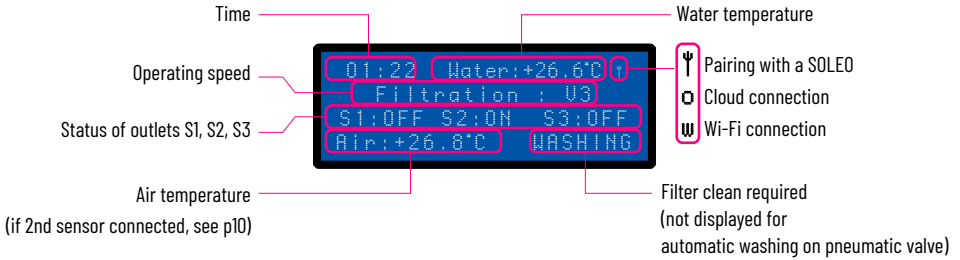

Radio menu (radio pairing between SOLEO and Speedeo Connect)

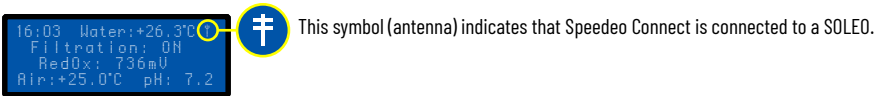

- i** The default radio channel is Channel 01 (same for SPEEDEO). The devices have a range of 30 m. A SOLEO and a Speedeo Connect set on the same radio channel and at a distance maximum 30 m will automatically be paired. If several different Combi installations are close to each other, it is possible to shift the radio channel of one of the installations to one of the other 9 channels (2 to 10) to prevent interference. It is therefore important to choose the same channel number on the 2 devices to be paired.

Home menu > Radio menu :

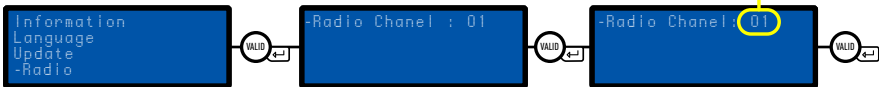

- i** If Speedeo Connect is linked to a SOLEO, the SOLEO filtration outlet is only supplied with power when Speedeo Connect starts the VS pump (whatever the speed). This SOLEO filtration outlet can for example be used to supply a UV light.

- Once Speedeo Connect is linked to a SOLEO, the temperature values saved and displayed by Speedeo Connect are picked up by the SOLEO.

Access to restricted access mode 'Install'

i Speedeo Connect controls the equipment in the technical room, and the wrong settings may have serious consequences for the safety of the pool. Because of this, access to certain initial configuration functions is reserved for professionals, or people whose experience enables them to modify these parameters while being fully aware of the consequences. In order to limit accidental access, the Install menu menu has secured access. (from the main menu, simultaneously hold down Esc and Valid for 3 secs. A star appears in the top right corner of the home screen).

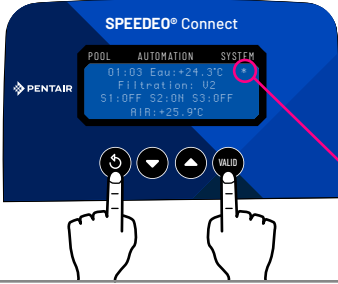

The **Install menu** is active. It automatically deactivates after 15 mins of inactivity.

Menu organisation / Heating menu / Information menu

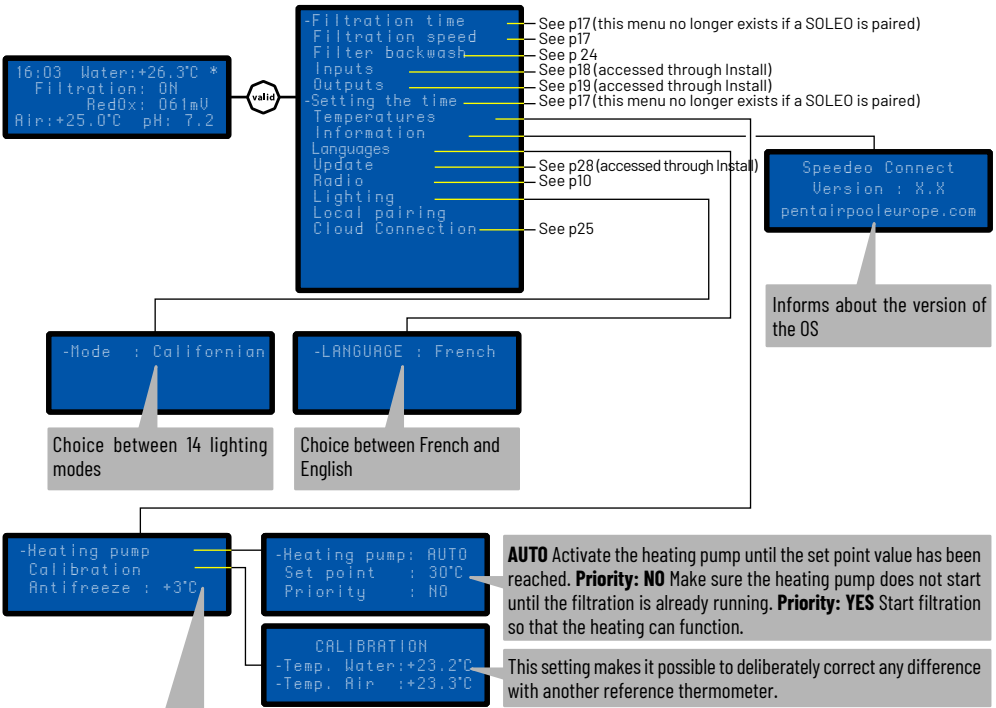

Below this temperature, the filtration runs 24/7 to prevent the pool from freezing (active wintering).
 - **If the air temperature probe is connected:** it becomes the reference value for freeze protection management. Place it outdoors, out of direct sunlight so that the measurements are not distorted (see p06). - **If the air temperature probe is not connected:** the water temperature becomes the reference value for freeze protection management. Please check that the technical room is not heated or has a significantly different temperature in comparison with the temperature outside. If this is the case, the difference must be compensated by **Calibration**.

Menu: Filtration time (daily) / Algorithm

i Speedeo Connect proposes 4 different algorithms to suit different preferences concerning the ratio of the number of hours for filtration according to the water temperature.

i - Once the Speedeo Connect is linked to a SOLEO, this menu Filtration time disappears. The SOLEO will manage the Filtration time.

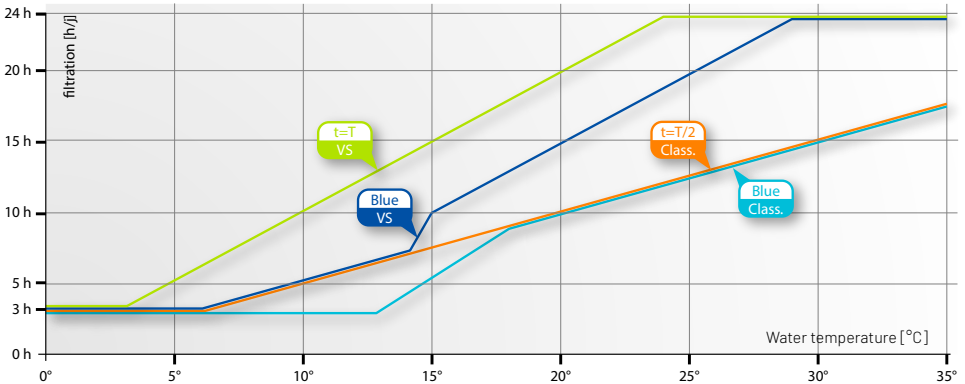

t=T VS (the daily filtration time is equal to the temperature value in ° Celsius): At 10 °C, filtration will function 10 hrs/day, at 20 °C 20h/day... Aimed at pumps with variable speed control, this mode filters the most.

BlueVS Aimed at pumps with variable speed control, this mode filters less, particularly at temperatures below 15 °C, where bacteria do not easily develop.

t=T/2Classic (the daily filtration time is equal to half the temperature value in ° Celsius): At 10 °C, filtration will function 5 hrs/day, at 20 °C 10 hrs/day ... Aimed at pumps with fixed speeds, this mode filters the most.

Blue Classic Aimed at pumps with fixed speeds, this mode filters less, particularly at temperatures below 15 °C, where bacteria do not easily develop.

1 - Start the secured Install menu (from the main menu, simultaneously hold down Esc and Valid for 3 secs. A star appears in the top right corner of the home screen).

2 - On the Filtration time / Algorithmsub-menu, select your chosen mode.

Menu: Filtration time / Auto/On/Off/Timer/Shock Mode

i - Once the Speedeo Connect is linked to a SOLEO, this menu Filtration time disappears. The SOLEO will manage the Filtration time.

Home menu > Filtration time menu:

```
-Filtration : ON
Start       : 05:00
Stop       : AUTO
mode       : TURBO
```

Select current mode:

AUTO = Automatically calculates the Filtration time according to the water temperature.

ON = Filtration runs 24/7.

OFF = Filtration stops (note - anti freeze mode becomes inactive).

TIMER = Filtration runs during the selected time period (see below)

CHOCK = Activates 24-hour filtration. This function can be useful after the pool has been used by many visitors and when the pool temperature is high. At the end of the mode **CHOCK**, Speedeo Connect returns to normal **AUTO**.

This menu gives you control of the filtration start and end time, to control the level of noise linked to your pool (filtration noise), for the sake of the neighbourhood. By default, leave **End** on **AUTO**.

In **AUTO**, Speedeo Connect calculates the filtration end time.

Filtration speed menu

In **AUTO**, these events which adjust the different rotation speeds for the pumps with variable speeds. The field for **Events** will appear.

MANUAL displays the field **Speed** which enables manual selection of the rotation speed for the pumps with variable speeds.

Home menu > Filtration time menu:

```
-Mode: AUTO      -Mode : MANUAL
Events           Speed : S2
```

```
S2 timer : YES
Start    : 11:00
End      : 16:00
S3 timer : YES
Start    : 17:00
End      : 18:00
Cover open : NO
Heating  : NO
S3 inlet 1 : YES
```

Event creation:

S2 timer = If **YES** the pump is running at S2 from the Start time to End.

S3 timer = If **YES** the pump is running at S3 from the Start time to End.

Cover open = Opening the cover (if connected) changes the speed from S1 to S2.

Heating = Starting the heating pump (see p15) activates S2.

Inlet 1 S3 = Closing a contact at Inlet 1 starts S3 (e.g. connecting a switch for activating a waterfall, an animation, swimming against the current...).

Time set menu

i - Once the Speedeo Connect is linked to a SOLEO, this menu Setting the time disappears. The SOLEO will manage the time settings.

```
-Heure : 16 h
Minute : 03 min
```

Makes it possible to set the time of the device. If the power supply is interrupted for more than 30 min., reinstalling the time is necessary.

Inlet: connection for the end of a cover line

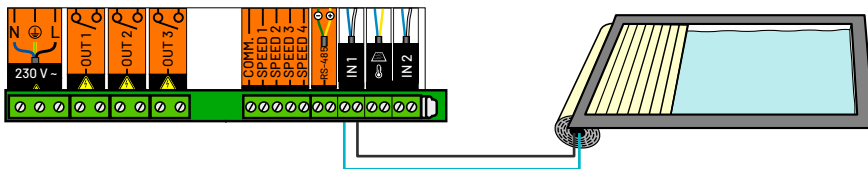

i The contact is closed when the cover is covering the pool

- 1 - Connect the cables in accordance with the diagram.
- 2 - Start the secured **Install menu** (from the main menu, simultaneously hold down **Esc** and **Valid** for 3 secs. A star appears in the top right corner of the home screen).
- 3 - On the **Inlets / EI-E2** sub-menu (in accordance with chosen terminal), select **COVER CONTACT** to indicate that a limit contact has been connected to the corresponding inlet.
- 4 - On the **Filtration time / Cover Open** sub-menu, select **YES** so that filtration is carried out while the cover is open (the cover does not cover the pool). This is the primary function of the **Filtration time / Start** setting (despite the setting of an hour from the start and/or end of filtration, if the cover does not cover the pool all day, filtration will run all day).
- 5 - On the **Filtration Speed / Events / Cover Open** sub-menu, select **YES** so that the filtration speed changes from S1 to S2.

Inlet: connection for a switch, a remote control...

i It is possible to connect any type of dry contact inlet (switch, remote control, relay) which activates an outlet.

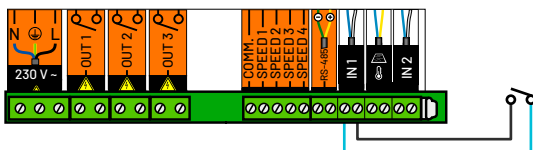

- 1 - Connect the cables in accordance with the diagram.
- 2 - Start the secured **Install menu** (from the main menu, simultaneously hold down **Esc** and **Valid** for 3 secs. A star appears in the top right corner of the home screen).
- 3 - On the **Inlets / EI-E2** sub-menu (in accordance with chosen terminal), select **OTHER** to indicate that a dry contact has been connected to the corresponding inlet.

Inlet: connection for an air temperature probe (see p10)

Outlet: control connection (chlorine or pH)

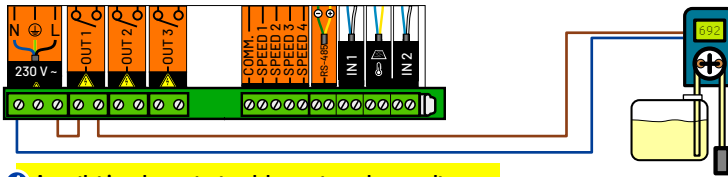

i An outlet is a dry contact and does not supply any voltage.

1 - Connect the cables in accordance with the diagram.

2 - Start the secured **Install menu** (from the main menu, simultaneously hold down **Esc** and **Valid** for 3 secs. A star appears in the top right corner of the home screen).

3 - On the **Outlets / S1-S2-S3** sub-menu (in accordance with chosen terminal), select **CONTROL** to indicate that a control (any kind) has been connected to the corresponding outlet.

This contact is closed (active outlet) while the filtration is running, whatever the rotation speed. The connected control is guaranteed to function while the filtration pump is running.

PENTAIR IntelliChlor: Connections and functions

i Connect the pump to the 230 V, connect the 10-m long IntelliFlo cable (ref 350122), the green/yellow to the 'RS-485', adhering to the colours.

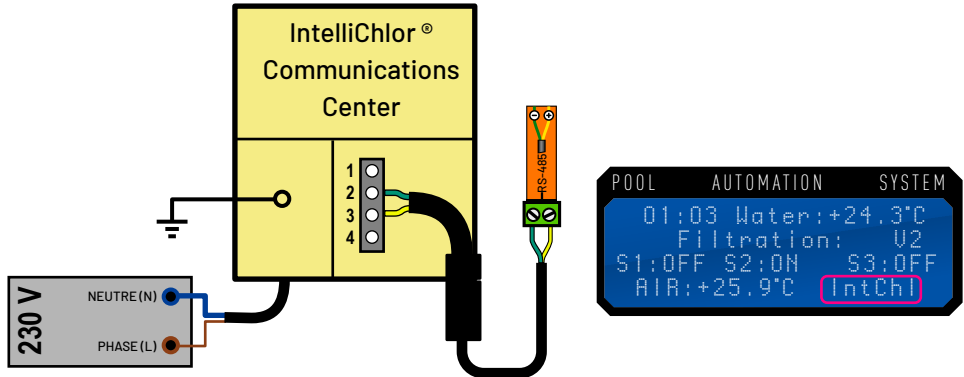

1 - Connect the cables in accordance with the diagram.

2 - At the Home screen, wait for a few seconds and the indication for **IntChl** will appear.

Outlet: heating connection

Connection via a dedicated contact (contact automation)

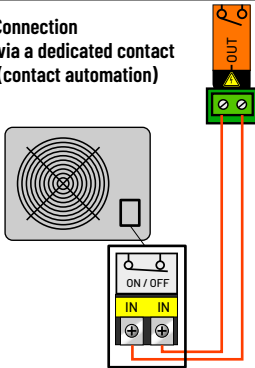

Connection via a contactor

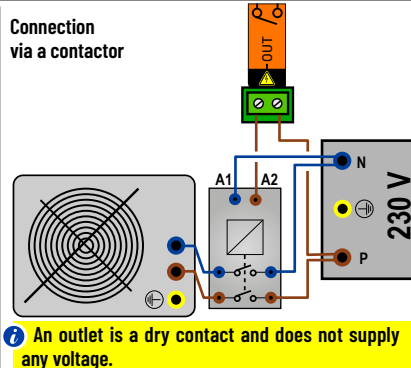

Connection via the safety shutdown (flow switch)

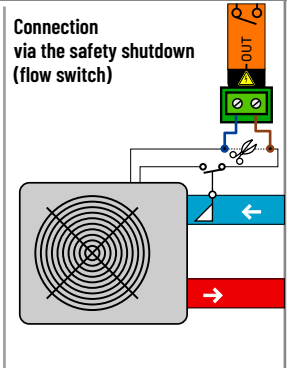

- 1 - Connect the cables in accordance with the chosen diagram.
- 2 - Start the secured **Install menu** (from the main menu, simultaneously hold down **Esc** and **Valid** for 3 secs. A star appears in the top right corner of the home screen).
- 3 - On the **Outlets / S1-S2-S3** sub-menu (in accordance with chosen terminal), select **HEATING PUMP** to indicate that a heating pump (any kind) has been connected to the corresponding outlet.
- 4 - Via **Temperature menu > Heating pump** :
 - > Select **OFF** to cut off the heating pump.
 - > Select **AUTO** to ensure that the temperature is controlled automatically. A menu **Setpoint** will then appear. > Select **Setpoints** to change the target value. A menu **Priority** will then appear. > Select **Priority** to activate or not. The priority will activate the filtration and heating pump, even if filtration has been stopped. Do not activate the priority when the heating pump has been activated, unless the filtration is running for another reason.
- 5 - Via **Temperature menu > Calibration** : Manual correction of the temperature concerned. Enables adjustment of temperature, using another thermometer as a reference.
- 6 - Via **Temperature menu > Anti freeze** : Temperature where filtration is forced to prevent the pool from freezing. The heating pump is not used for anti freeze protection.

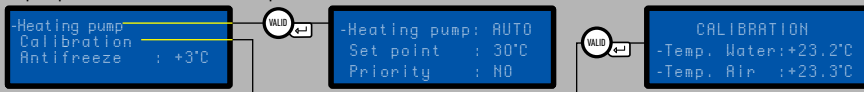

Output: Connection of an InverTemp heater with an RS-485

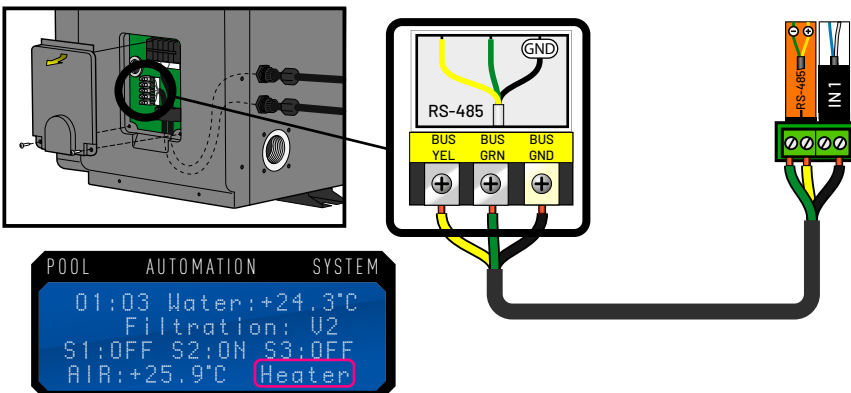

- 1 - Connect the cables according to the diagram.
- 2 - Switch on, wait a few seconds, the word **Heater** appears at the bottom of the home screen.

Outlet: solar heating connection

i An outlet is a dry contact and does not supply any voltage.

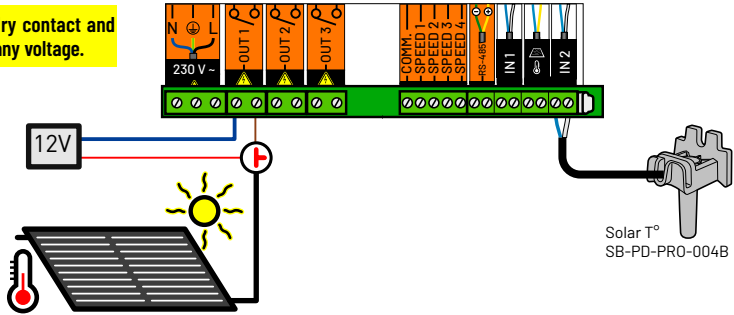

- 1 - Connect the cables in accordance with the diagram.
- 2 - Start the secured **Install menu** (from the main menu, simultaneously hold down **Esc** and **Valid** for 3 secs. A star appears in the top right corner of the home screen).
- 3 - On the **Inlets / E2** sub-menu, select **Solar T°** to indicate that the SB-PD-PRO-004B temperature sensor is connected to the corresponding inlet.
- 4 - On the **Outlets / S1-S2-S3** sub-menu (in accordance with chosen terminal), select **SOLAR** to indicate that a solar heater is connected to the corresponding outlet.
- 5 - On the **Temperature / Solar** sub-menu, configure the settings:

```
Solar : AUTO
Temp difference:4°C
Delta heating : -2°C
```

AUTO: Activates solar heating and uses all available calories.
Temp difference: Difference between solar T°/pool T° which activates the solar heating.
Delta heating: Decreases T° set point for non-solar heating, so that solar heating can be the primary type used.

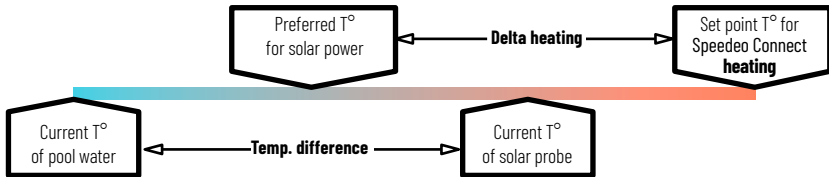

Outlet: connection for lighting below 1,600 W

i An outlet is a dry contact and does not supply any voltage.

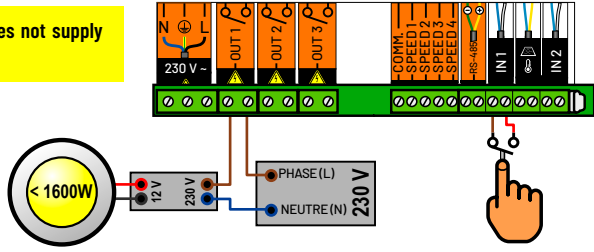

- 1 - Connect the cables in accordance with the diagram.
- 2 - Start the secured **Install menu** (from the main menu, simultaneously hold down **Esc** and **Valid** for 3 secs. A star appears in the top right corner of the home screen).
- 3 - On the **Inlets / E1** sub-menu, select **LIGHTING** to indicate that a dry contact has been connected to the corresponding inlet.
- 4 - For IntelliBrite and other LED lights with colours that may change with impulses, on the Home menu, select **Lighting** and validate the chosen light programme type:



Outlet: connection for a 3-way motorised valve (OTHER)

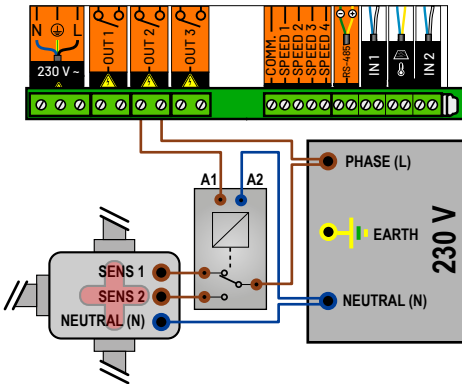

- 1 - Connect the cables in accordance with the diagram.
- 2 - Start the secured **Install menu** (from the main menu, simultaneously hold down **Esc** and **Valid** for 3 secs. A star appears in the top right corner of the home screen).
- 3 - On the **Outlets / S1-S2-S3** sub-menu (in accordance with chosen terminal), select **OTHER** to indicate that a motorised valve is connected to the corresponding outlet.

i An outlet is a dry contact and does not supply any voltage.

Outlet: connection for a pneumatic valve (Filter backwash)

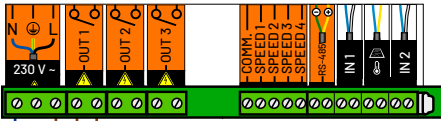

i An outlet is a dry contact and does not supply any voltage.

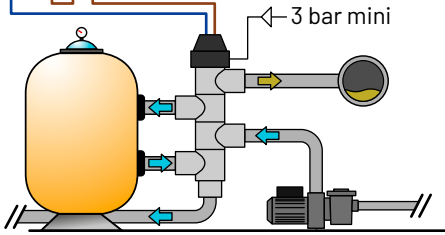

- 1 - Connect the cables in accordance with the diagram.
- 2 - Start the secured **Install menu** (from the main menu, simultaneously hold down **Esc** and **Valid** for 3 secs. A star appears in the top right corner of the home screen).
- 3 - On the **Outlets / S1-S2-S3** sub-menu (in accordance with chosen terminal), select **Filter backwash** to indicate that a pneumatic valve is connected to the corresponding outlet.
- 4 - On the **Filter backwash > Auto Washing** sub-menu, select **YES** or **NO** so that Filter backwash runs automatically for the time length entered in the **Filter backwash / Filtration: 100 hrs**
- 5 - On the **Filter backwash / Filtration: 100 hrs** sub-menu, modify the number of filtration hours (whatever the speed) after which automatic washing is activated.

If automatic Filter backwash is activated, manual washing can still be accessed. If Filter backwash is started manually, the filtration time meter which activates automatic backwash is reset to zero.

- 6 - On the **Filter backwash > Washing: 70 secs** sub-menu, modify the filtration washing time.

Automatic Filter backwash with pneumatic valve

i Speedeo Connect enables the filter to be cleaned automatically if a pneumatic valve is connected. However, an operator can force Filter backwash. Rinsing is not controlled by a pneumatic valve.

Home menu > Filtration menu > Filter backwash:

```
Manual Backwash
Filtration : 100 hrs
backwash : 70 s
Auto washing: NO
```

1 - Select **manual backwash** then hold down **VALID**. An automatic cycle can be started for the time lengths entered (factory pre-set at 70 secs) in the **Washing position**. There is no **Rinsing position** field (not applicable to a pneumatic valve).

```
'Valid' to
start washing
```

Press **VALID** to start the procedure.

```
Stop
filtration
```

Speedeo Connect has stopped the filtration pump. This display only remains for 2 seconds.

```
Washing in
progress 7secs
```

Speedeo Connect starts the filtration pump activation for the length of time entered into the **Washing field: XX**.

```
Stop
filtration
```

Speedeo Connect has stopped the filtration pump. This display lasts for 2 seconds.

Assisted backwash: Backwash support for the filter on the 6-way valve.

i Speedeo Connect supports you in washing the filter by chronologically proposing the different required steps.

Welcome menu > Filter backwash:

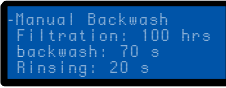

```
Manual Backwash
Filtration: 100 hrs
backwash: 70 s
Rinsing: 20 s
```

1- On the **Filter backwash** sub-menu, enter the Filtration time (factory pre-set at 100 hours), which activates the alert requesting Filter backwash, the desired washing time length (factory pre-set at 70 secs) and enter the desired filter rinsing time length (factory pre-set at 20 secs). These time lengths can be personalised by following the recommendations for your installation.

Filtration menu > Filter backwash > Manual backwash: **VALID**_____



```
Valid to
start
washing
```

Press **VALID** to start the procedure.



```
Put into position
backwash + 'Valid'
```

Put the 6-way valve in the 'Rinsing' position and then hold down **VALID**.



```
Washing in
progress 7secs
```

Speedeo Connect starts the filtration pump for the length of time entered into the **Washing: XX secs.**



```
Stop
filtration
```

Speedeo Connect has stopped the filtration pump. This display lasts for 2 seconds



```
Put into position
Rinsing + 'Valid'
```

Put the 6-way valve in the 'Rinsing' position and then hold down **VALID**.



```
Rinsing in
progress 17secs
```

Speedeo Connect starts the filtration pump for the length of time entered into the **Rinsing field: XX secs.**



```
Stop
filtration
```

Speedeo Connect has stopped the filtration pump. This display lasts for 2 seconds.



```
Put into position
Filtration + Valid
```

Put the 6-way valve in the 'Filtration' position and then hold down **VALID**. The procedure is finished.

Wi-Fi installation

- i** Speedeo Connect will connect directly to your Wi-Fi router via the Cloud Connection menu (Internet box).

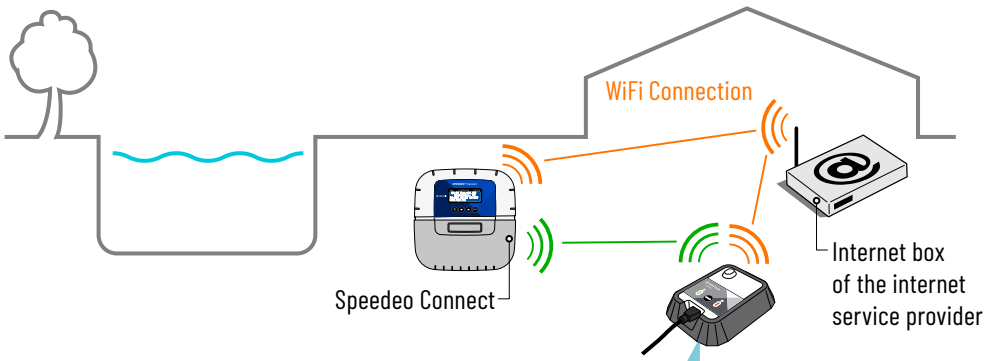

- i** If the distance does not allow for a stable direct Wi-Fi connection, the addition of a Gateway SB-PF-GTW-001A is necessary.

- # 1: Establish the electrical connections according to your configuration and start your Speedeo Connect.
- # 2: Open the Pentair Home application under your account. In the setup menu of a new device, choose Speedeo Connect, on the next screen asking if you are using a gateway to connect your Speedeo Connect to Wi-Fi, select "No, I will connect Speedeo directly to Wi-Fi".
- # 3: Make sure your smartphone's Bluetooth is enabled. Follow the suggested steps. Your Speedeo Connect will be detectable as «PNRS1SPD100000xxxx». Select it.
- # 4: Continue through the suggested menus by selecting your Wi-Fi network and fill in the requested credentials and continue until you are "Connected". Now your Speedeo Connect is connected to your Wi-Fi network.

General maintenance.

- i** Clean the outside with a dry microfiber cloth. Do not use solvent, abrasive or acid.

- Filtration Time (Even if connected to Soleo, Speedeo Connect is the master)

- Filtration: AUTO, SHOCK, TIMER, OFF, ON
- Start: 07h00
- End: Auto
- * — Algorithm: t=T VS, BlueVS, T/2Cla, BluCla
- * — Frost-free: +3°C
- * — Shutter open: OUI, NON

- Filtration Speed

- * — Type: Single speed, 3 speeds, 4 speeds, 4 speed.+stop, 3speed.+stop
- Mode: AUTO, MANUAL
- If Manual, Speed: V1, V2, V3, V4 (in manual mode)
- If Auto: V1 mode (IF): Velocity, Flux > Velocity 1: 22% or Flux V1: 9.0 m3/h
- If Auto: V2 mode (IF): Velocity, Flux > Velocity 2: 43% or Flux V2: 9.0 m3/h
- If Auto: V3 mode (IF): Velocity, Flux > Velocity 3: 68% or Flux V3: 9.0 m3/h
- If Auto: V4 mode (IF): Velocity, Flux > Velocity 4: 90% or Flux V4: 9.0 m3/h
- Events
 - Forced filtration: YES, NO
 - S2 timer: YES, NO
 - Start: 11:00
 - End: 16:00
 - S3 timer: YES, NO
 - Start: 11:00
 - End: 16:00
 - Cover open: YES, NO
 - Heating: YES, NO
 - S3 inlet 1: YES, NO

- Filter backwash

- Manual backwash: 'Valid' to start washing
- Filtration: 100 h
- Washing: 70 secs
- Rinsing: 30 secs
- Auto washing: YES, NO

- Temperatures

- Heating
 - Heating: AUTO, OFF
 - Set point: 25 °C
 - Mode: Smart / Eco / Boost (only with RS-485 connection)
 - Range: YES, NO
 - Start: 7:00
 - End: 23:00
 - Priority: YES, NO
 - Tempo Stop: 01 min.
- Solar
 - Solar: AUTO, OFF
 - Temp difference: 3 °C
 - Delta heating: -3 °C
- * — Calibration
 - Temp. water: 25.1 °C
 - Temp. air: 27.8 °C
- Antifreeze: +3°C

- Lighting

Mode : Mono Color, SAm, Party, Romance, Caribbean, American, California, Royal, Blue, Green, Red, White, Magenta

* Inlets

E1: LIGHTING, OTHER, COVER CONTACT, NOT CONNECTED
E2: Air T°, Solar T°, COVER CONTACT, NOT CONNECTED

* Outlets

S1: LIGHTING, NC, WEEKLY SHOCK, OTHER, Filter backwash, CONTROL, HEATING, SOLAR
S2: LIGHTING, NC, WEEKLY SHOCK, OTHER, Filter backwash, CONTROL, HEATING, SOLAR
S3: LIGHTING, NC, WEEKLY SHOCK, OTHER, Filter backwash, CONTROL, HEATING, SOLAR

- Setting the time

Time: 11 hrs
Minute: 55 min.

- Information

Speedeo Connect
Sever connected
Firmware V1.17(001)
<http://www.pentairpooleurope.eu>

- Languages

LANGUAGE: FRANCAIS, ENGLISH, NL

- Update

Firmware update put the USB key and hold down the up arrow key

- Radio Soleo

Radio Channel: 03 (Put the same as Soleo)

- Local pairing

Add device
Pairing in progress, please wait

- Cloud Connection

Connection: Wi-Fi, Gateway

- Wi-Fi information

PNRS1SPD100000xxxx
Server connected
RSSI : - 40dBm
Wi-Fi v²: 1.03

- Wi-Fi provisioning

Provisioning Lauch App & select PNRSPD100000xxxx Provisioning mode

- Gateway

Gateway pairing
Pairing with Gateway PNRSPD100000xxxx, Pairing done

- History (press ESC KEY in the main menu)

DAY IN PROGRESS: Filtration: , Outlet 1, Outlet 2, Outlet 3
DAILY HISTORY 1: Filtration: , Outlet 1, Outlet 2, Outlet 3

How to update the internal firmware



- 1.1 - Unzip the MAJ_SpeedeoC.zip file to obtain the SpeedeoC.bin file.
- 1.2 - Copy the SpeedeoC.bin file to the main folder of the USB stick formatted in FAT 16 or FAT 32.

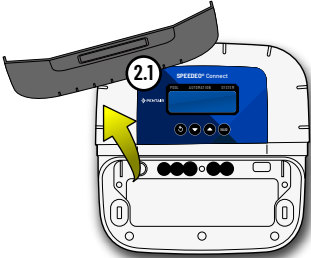

- 2.1 - Remove the soft cover, then remove the orange cover

!! DO NOT TOUCH THE ELECTRICAL CONNECTIONS. RISK OF ELECTROCUTION! ONLY PROFESSIONALS AUTHORISED TO WORK WITH LIVE INSTALLATIONS MAY WORK ON THE CONNECTED DEVICE WITHOUT A SAFETY COVER.

Home menu > Update menu :

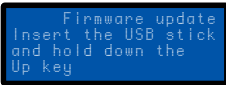

- 3.1 - Select the update menu

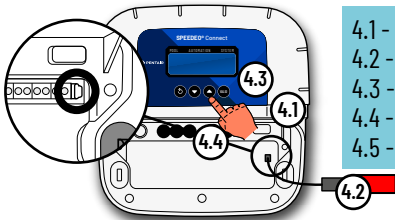

- 4.1 - Connect the USB cable supplied to the mini USB connector.
- 4.2 - Connect the USB stick to the end of the USB cable
- 4.3 - Press on the "up arrow / +" for more than 1 sec.
- 4.4 - The red and orange indicators light up.
- 4.5 - Wait for the orange indicator to remain off for 5 sec.

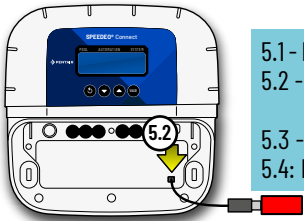

- 5.1 - Disconnect the USB stick (the orange indicator lights up)
- 5.2 - In the main menu at the bottom, under Information, read the version no.: X.X and check that it has changed.
- 5.3 - Replace the orange safety cover
- 5.4: Replace the soft cover.

History menu

i This menu makes it possible to find the daily and previous day's activity of each connected piece of equipment.

- 1 - Access the secured DAILY HISTORY menu by holding down Esc :

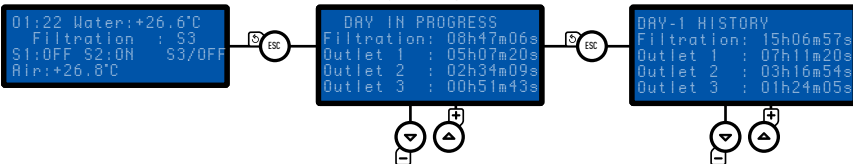

Variations in the RedOx(ORP) according to the pH and the chlorine rate in water without a stabiliser at a temperature of 18°C.

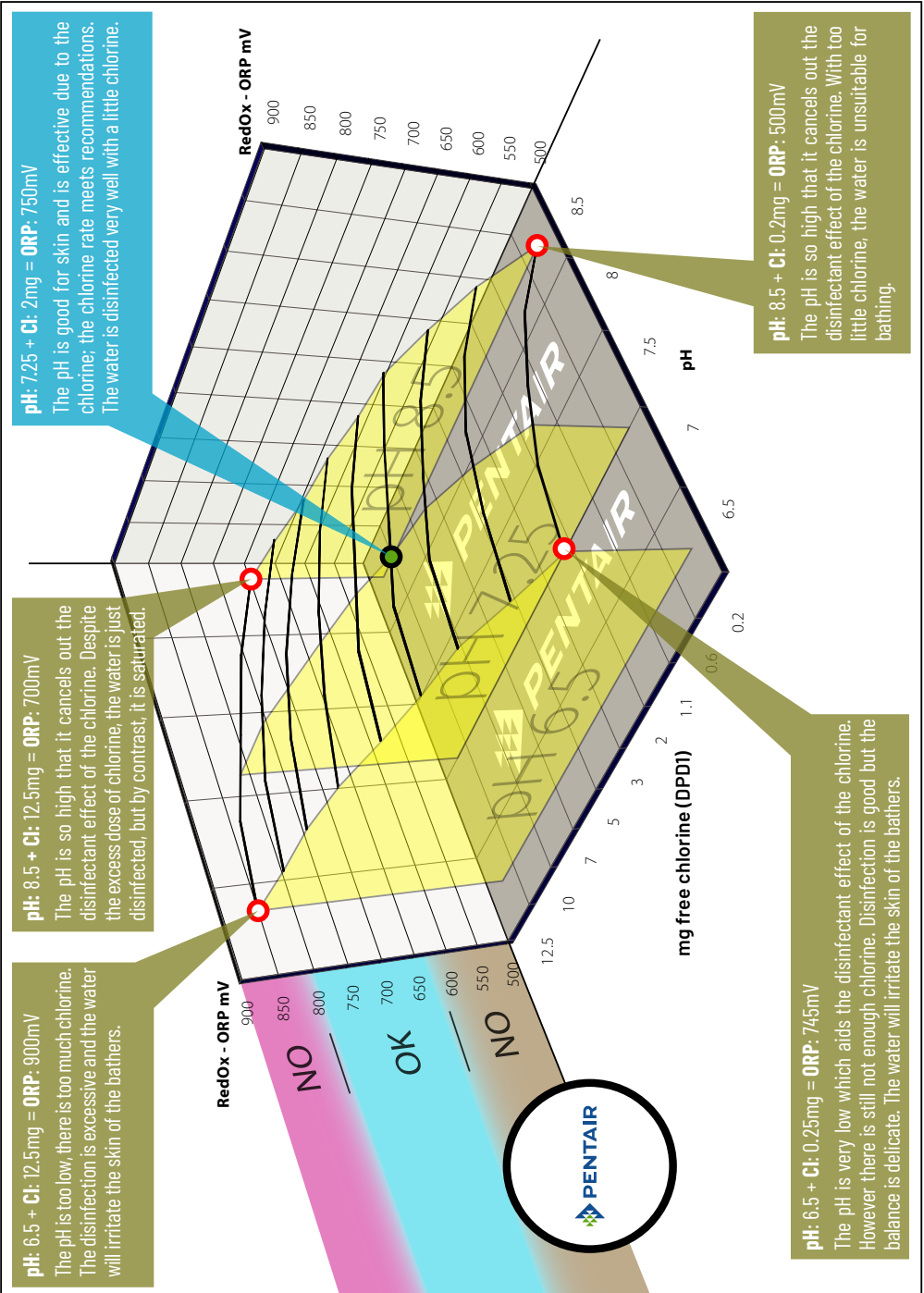



Pentair International SARL

Ave. de Sévelin 20, CH-1004 - LAUSANNE, Switzerland

Copyright - Limited License: except as specifically permitted herein, no portion of the content on this document may be reproduced in any form or by any mean without the prior written permission of Pentair International SRL.

Ave. de Sévelin 20, CH-1004 - LAUSANNE, Suisse

Copyright - Licence limitée: sauf autorisation expresse des présentes, aucune partie du contenu de ce document ne peut être reproduite sous quelque forme que ce soit ou par quelque moyen que ce soit sans l'autorisation écrite préalable de Pentair International SRL.

Ave. de Sévelin 20, CH-1004 - LAUSANNE, Switzerland

Copyright - Beperkte licentie: behalve indien uitdrukkelijk anders vermeld mag geen onderdeel van dit document in gelijk welke vorm of op gelijk welke manier gereproduceerd worden zonder de voorafgaande schriftelijke toestemming van Pentair International SRL.

Ave. de Sévelin 20, CH-1004 - LAUSANNE, Switzerland

Copyright - Begrenzte Lizenz: Sofern dieses Dokument keine ausdrückliche Genehmigung enthält, dürfen keine Bestandteile der Inhalte des vorliegenden Dokuments in jeglicher Form oder mit Hilfe jeglicher Mittel ohne die vorherige schriftliche Zustimmung von Pentair International SRL vervielfältigt werden.

Ave. de Sévelin 20, CH-1004 - LAUSANNE, Suíça

Copyright - Licença limitada: salvo en lo expresamente permitido en el presente documento, se prohíbe la reproducción total o parcial del mismo por cualquier medio sin la previa autorización por escrito de Pentair International SRL.

Ave. de Sévelin 20, CH-1004 - LAUSANNE, Svizzera

Copyright - Licenza limitata: se non indicato specificatamente di seguito, nessuna porzione del contenuto di questo documento può essere riprodotta in qualsiasi forma o con qualsiasi mezzo senza preventiva autorizzazione scritta di Pentair International SRL.

Av. de Sévelin 20, CH-1004 - LAUSANNE, Suíça

Copyright - Licença Limitada: Exceto conforme permitido especificamente no presente, nenhuma parte do conteúdo no presente documento poderá ser reproduzida, de qualquer forma ou por qualquer meio, sem consentimento prévio por escrito da Pentair International SRL.